

SIZE GUIDE



HOW TO MEASURE

1. Lay your previous favourite garment flat on table.
2. Use a tape and measure down 4cm down under armpit.
3. Use a tape to measure across front chest as shown (A).

A = Half Chest is the most important measurement.

Determine the measurement in cms and compare against the provide chart for that garment.

Sizing changes with different garments as garments are designed to be worn differently.

eg, A measurement of 56cm across the front chest equals Med.

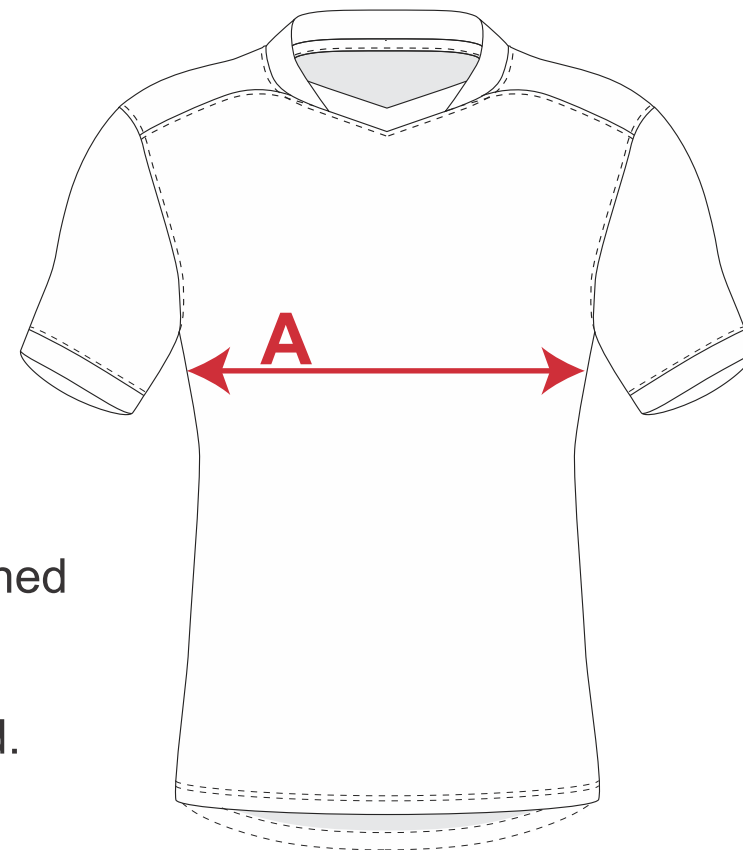

MENS K2 PRO JERSEY

MEASUREMENT POINT	XS	S	M	L	XL	2XL	3XL	4XL
1/2 CHEST WIDTH	52.5	54.5	56.5	58.5	60.5	62.5	64.5	66.5
1/2 HEM	53	55	57	59	61	63	65	67
BACK BODY LENGTH	70.5	72.5	74.5	76.5	78.5	80.5	82.5	84.5

MENS EVEREST JERSEY - EVEREST ELITE SPEC

MEASUREMENT POINT	XS	S	M	L	XL	2XL	3XL	4XL
1/2 CHEST WIDTH	47	49	51	53	55	57	59	61
1/2 HEM	39	40	42	44	46	48	50	52
BACK BODY LENGTH	66	68	70	72	74	76	78	80

JUNIOR EVEREST JERSEY - EVEREST ELITE SPEC

MEASUREMENT POINT	4	6	8	10	12
1/2 CHEST WIDTH	37	39	41	43	45
1/2 HEM	34	35	36	37	38
BACK BODY LENGTH	51	54	57	60	63

WOMEN EVEREST JERSEY - EVEREST ELITE SPEC

MEASUREMENT POINT	W4	W6	W8	W10	W12	W14	W16	W18	W20	W22	W24
1/2 CHEST WIDTH	40	43	46	48	51	54	58	61	65	68	70
1/2 HEM	43	46	49	51	54	57	61	64.5	68	70	72
BACK BODY LENGTH	60	62	66	67	69	72	74	76	78	78	81

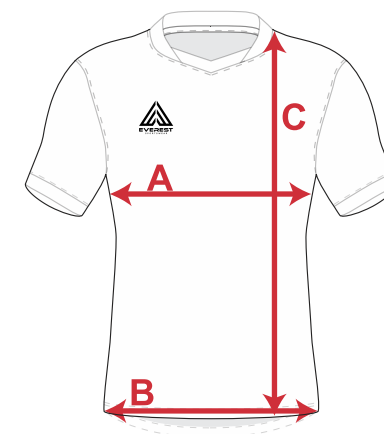

A - CHEST WIDTH
B - HEM WIDTH
C - BODY LENGTH

MENS K2 PRO JERSEY
AUSTRALIAN SPORTSWEAR SPEC

MEASUREMENT POINT	XS	S	M	L	XL	2XL	3XL	4XL
1/2 CHEST WIDTH	50.5	54.5	56.5	58.5	60.5	62.5	64.5	66.5
1/2 HEM	51	55	57	59	61	63	65	67
BACK BODY LENGTH	66	68	70	72	74	76	78	80

SIZES ARE LISTED IN CM

MENS K2 PRO SINGLET EVEREST SPORTSWEAR SPEC

MEASUREMENT POINT	XS	S	M	L	XL	2XL	3XL	4XL
1/2 CHEST WIDTH	50.5	54.5	56.5	58.5	60.5	62.5	64.5	66.5
1/2 HEM	51	55	57	59	61	63	65	67
	66	71	74	76	78	80	82	84

JUNIOR K2 PRO SINGLET EVEREST SPORTSWEAR SPEC

MEASUREMENT POINT	4	6	8	10	12
1/2 CHEST WIDTH	37	39	41	43	45
1/2 HEM	35	37	39	41	43
BACK BODY LENGTH	44	46	50	54	58

WOMENS K2 PRO SINGLET EVEREST SPORTSWEAR SPEC

MEASUREMENT POINT	W4	W6	W8	W10	W12	W14	W16	W18	W20	W22	W24
1/2 CHEST WIDTH	40	43	46	48	51	54	58	61	65	68	70
1/2 HEM	43	46	49	51	54	57	61	64.5	68	70	72
BACK BODY LENGTH	60	62	63	65	68	70	72	74	76	78	80

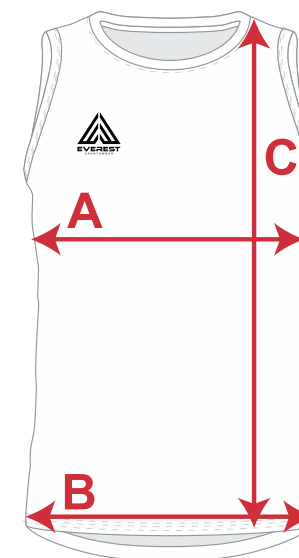

A - CHEST WIDTH
B - HEM WIDTH
C - BODY LENGTH

MENS K2 PRO TEE EVEREST SPORTSWEAR SPEC

MEASUREMENT POINT	XS	S	M	L	XL	2XL	3XL	4XL
1/2 CHEST WIDTH	50.5	54.5	56.5	58.5	60.5	62.5	64.5	66.5
1/2 HEM	51	55	57	59	61	63	65	67
BACK BODY LENGTH	66	71	74	76	78	80	82	84

JUNIOR K2 PRO TEE EVEREST SPORTSWEAR SPEC

MEASUREMENT POINT	4	6	8	10	12
1/2 CHEST WIDTH	37	39	41	43	45
1/2 HEM	35	37	39	41	43
BACK BODY LENGTH	44	46	50	54	58

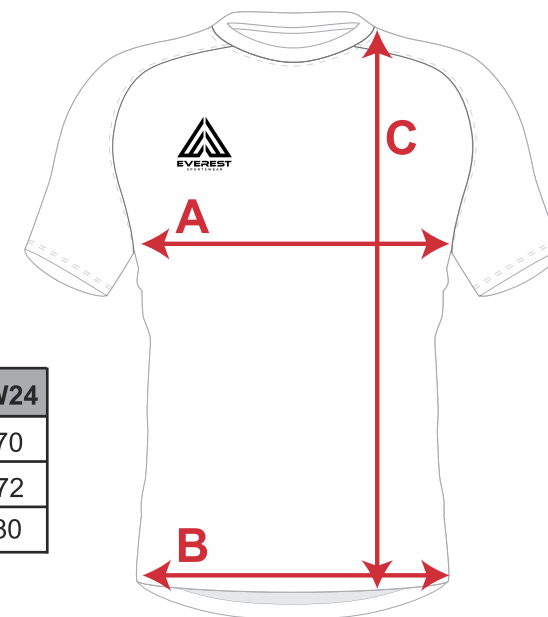

WOMENS K2 PRO TEE EVEREST SPORTSWEAR SPEC

MEASUREMENT POINT	W4	W6	W8	W10	W12	W14	W16	W18	W20	W22	W24
1/2 CHEST WIDTH	40	43	46	48	51	54	58	61	65	68	70
1/2 HEM	43	46	49	51	54	57	61	64.5	68	70	72
BACK BODY LENGTH	60	62	63	65	68	70	72	74	76	78	80

A - CHEST WIDTH
B - HEM WIDTH
C - BODY LENGTH

MENS K2 PRO POLO EVEREST SPORTSWEAR SPEC

MEASUREMENT POINT	XS	S	M	L	XL	2XL	3XL	4XL	5XL	6XL
1/2 CHEST WIDTH	50.5	54.5	56.5	58.5	60.5	62.5	64.5	66.5	68	70
1/2 HEM	51	55	57	59	61	63	65	67	67.5	69.5
BACK BODY LENGTH	66	71	74	76	78	80	82	84	84.5	86.5

JUNIOR K2 PRO POLO EVEREST SPORTSWEAR SPEC

MEASUREMENT POINT	4	6	8	10	12
1/2 CHEST WIDTH	37	39	41	43	45
1/2 HEM	35	37	39	41	43
BACK BODY LENGTH	44	46	50	54	58

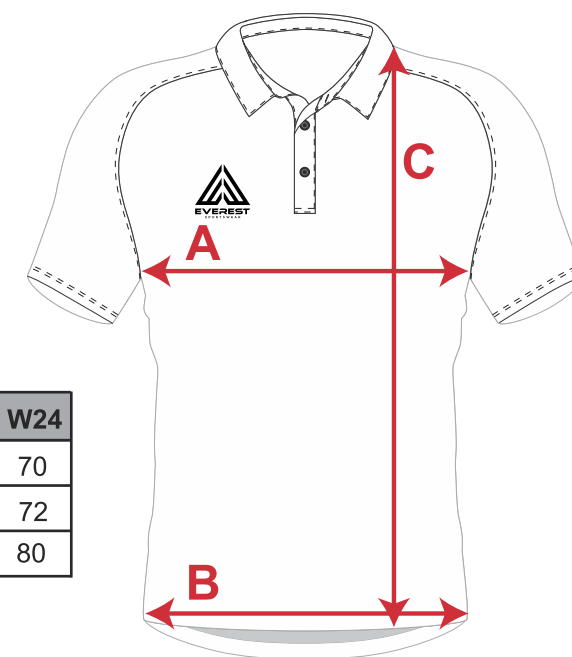

WOMENS K2 PRO POLO EVEREST SPORTSWEAR SPEC

MEASUREMENT POINT	W4	W6	W8	W10	W12	W14	W16	W18	W20	W22	W24
1/2 CHEST WIDTH	40	43	46	48	51	54	58	61	65	68	70
1/2 HEM	43	46	49	51	54	57	61	64.5	68	70	72
BACK BODY LENGTH	60	62	63	65	68	70	72	74	76	78	80

A - CHEST WIDTH
B - HEM WIDTH
C - BODY LENGTH

MENS K2 PRO SHORTS - GYM (AUSTRALIAN SPEC)

MEASUREMENT POINT	XS	S	M	L	XL	2XL	3XL	4XL	5XL
1/2 WAIST WIDTH	34	35	37.5	40	42.5	45	47.5	50	52.5
FRONT RISE INCLUDING HEM	30	31	32	33	34	35	36	37	38
LENGTH INCLUDING HEM	41	42	43	44	45	46	47	48	49
1/2 LEG OPENING	31	33	35	36.5	38	39.5	41	42.5	43.5

JUNIOR K2 PRO SHORTS - GYM (EVEREST SPORTSWEAR SPEC)

MEASUREMENT POINT	K4	K6	K8	K10	K12
1/2 WAIST WIDTH	22	25	27.5	30	32
FRONT RISE INCLUDING HEM	25	26	27	28	29
LENGTH INCLUDING HEM	32	32.5	34	36	38
1/2 LEG OPENING	20	23	25	28	30

BACKRISE 12CM LONGER ON ALL SIZING

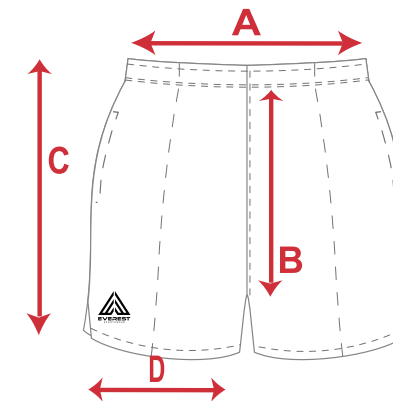

WOMENS K2 PRO - GYM (EVEREST SPORTSWEAR SPEC)

MEASUREMENT POINT	W8	W10	W12	W14	W16	W18	W20	W22	W24	W26
1/2 WAIST WIDTH	32.5	35	37.5	40	42.5	45	47.5	50	52.5	52.5
FRONT RISE INCLUDING HEM	25	26	27	28	29	30	31	33	34	35
LENGTH INCLUDING HEM	37	37.5	38	39	39.5	40	40.5	41	41.5	42
LEG OPENING	30	31	32	33	34	36	38	38.5	39	40

BACKRISE 12CM LONGER ON ALL SIZING

A - WAIST WIDTH
B - FRONT RISE

EVEREST ELITE RUGBY SHORTS - MENS

MEASUREMENT POINT	S	M	L	XL	2XL	3XL	4XL	5XL
1/2 WAIST WIDTH - RELAXED	37	39	41	42.5	44	46	47	49
FRONT RISE INCLUDING WAISTBAND 3.5CM	34	35	36	37	38	39	40	41
LENGTH INCLUDING WAISTBAND	38	39	40	41	42	43	44	45

EVEREST ELITE RUGBY SHORTS - JUNIORS

MEASUREMENT POINT	K2	K4	SB-6	MB-8	LB-10	YTH-12
1/2 WAIST WIDTH - RELAXED	21	23	28	30	32	34
FRONT RISE INCLUDING WAISTBAND 3.5CM	24	26	25	27	29	31
LENGTH INCLUDING WAISTBAND	26	27.5	29	31	33	35

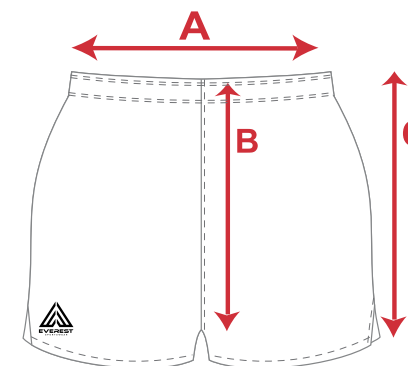

EVEREST ELITE RUGBY SHORTS - WOMENS

MEASUREMENT POINT	W6	W8	W10	W12	W14	W16	W18	W20	W22	W24
1/2 WAIST WIDTH - RELAXED	30	32	34	36	38	40	41.5	42	45	47
FRONT RISE INCLUDING WAISTBAND 3.5CM	24	25	26	27	28	29	30	31	32	33
LENGTH INCLUDING WAISTBAND	30	31	32	33	34	35	36	37	38	39

A - WAIST WIDTH
B - FRONT RISE

JUNIOR K2 PRO SHORTS - RUGBY EVEREST SPORTSWEAR SPEC

MEASUREMENT POINT	SB-6	MB-8	LB-10	YTH-12
1/2 WAIST WIDTH - RELAXED	25	28	31	33
FRONT RISE INCLUDING WAISTBAND 3.5CM	28	29	30	31
LENGTH INCLUDING WAISTBAND	29	30	31	32

SIZES ARE LISTED IN CM

MENS K2 PRO HOODY EVEREST SPORTSWEAR SPEC

MEASUREMENT POINT	XS	S	M	L	XL	2XL	3XL	4XL
1/2 CHEST WIDTH	55	57	59	61	63	65	67	69
1/2 HEM	54	56	58	60	62	64	65	67
BACK BODY LENGTH INCLUDING THE WAISTBAND	66	69	71	74	76	78	80	82

JUNIOR K2 PRO HOODY EVEREST SPORTSWEAR SPEC

MEASUREMENT POINT	K4	K6	K8	K10	K12
1/2 CHEST WIDTH	40.5	43.5	46.5	49.5	52
1/2 HEM	40.5	43.5	46.5	49.5	49.5
BACK BODY LENGTH INCLUDES WAISTBAND	48	50	53	59	64

WOMENS K2 PRO HOODY EVEREST SPORTSWEAR SPEC

MEASUREMENT POINT	W8	W10	W12	W14	W16	W18	W20	W22	W24
1/2 CHEST WIDTH	46	48	51	54	58	61	65	68	70
1/2 HEM	45	46	49	53	57	60	65	68	70
BACK BODY LENGTH INCLUDES WAISTBAND	61	63	65	68	70	72	74	76	78



A - CHEST WIDTH
B - HEM WIDTH
C - BODY LENGTH

EVEREST MID LAYER - MENS EVEREST SPORTSWEAR SPEC

MEASUREMENT POINT	XS	S	M	L	XL	2XL	3XL	4XL
1/2 CHEST WIDTH	55	57	59	61	63	65	67	69
1/2 HEM	54	56	58	60	62	64	65	67
BACK BODY LENGTH INCLUDING THE WAISTBAND	66	69	71	74	76	78	80	82

EVEREST MID LAYER - KIDS EVEREST SPORTSWEAR SPEC

MEASUREMENT POINT	K4	K6	K8	K10	K12
1/2 CHEST WIDTH	40.5	43.5	46.5	49.5	52
1/2 HEM	40.5	43.5	46.5	49.5	49.5
BACK BODY LENGTH INCLUDES WAISTBAND	48	50	53	59	64

EVEREST MID LAYER - WOMENS EVEREST SPORTSWEAR SPEC

MEASUREMENT POINT	W8	W10	W12	W14	W16	W18	W20	W22	W24
1/2 CHEST WIDTH	46	48	51	54	58	61	65	68	70
1/2 HEM	45	46	49	53	57	60	65	68	70
BACK BODY LENGTH INCLUDES WAISTBAND	61	63	65	68	70	72	74	76	78

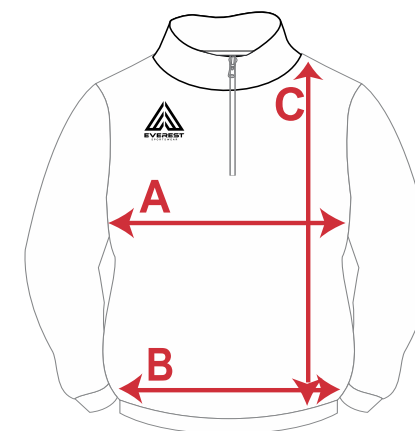

A - CHEST WIDTH
B - HEM WIDTH
C - BODY LENGTH

MENS K2 PRO JACKET EVEREST SPORTSWEAR SPEC

MEASUREMENT POINT	XS	S	M	L	XL	2XL	3XL	4XL
1/2 CHEST WIDTH	55	57	59	61	63	65	67	69
1/2 HEM	54	56	58	60	62	64	65	67
BACK BODY LENGTH INCLUDING THE WAISTBAND	66	69	71	74	76	78	80	82

JUNIOR K2 PRO JACKET EVEREST SPORTSWEAR SPEC

MEASUREMENT POINT	K4	K6	K8	K10	K12
1/2 CHEST WIDTH	40.5	43.5	46.5	49.5	52
1/2 HEM	40.5	43.5	46.5	49.5	52
BACK BODY LENGTH INCLUDES WAISTBAND	48	50	53	59	64

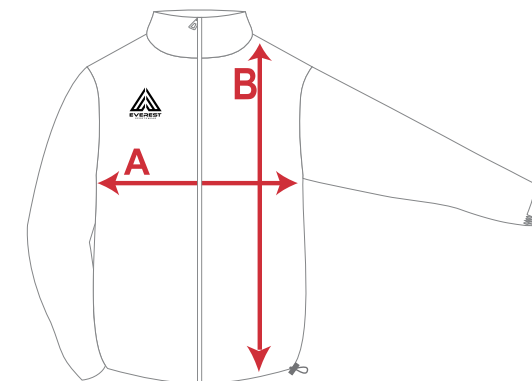

WOMENS K2 PRO JACKET EVEREST SPORTSWEAR SPEC

MEASUREMENT POINT	W8	W10	W12	W14	W16	W18	W20	W22	W24
1/2 CHEST WIDTH	46	48	51	54	58	61	65	68	70
1/2 HEM	45	46	49	53	57	60	65	68	70
BACK BODY LENGTH INCLUDES WAISTBAND	61	63	65	68	70	72	74	76	78

A - CHEST WIDTH
B - BODY LENGTH

**WIND
JACKET
SIZE GUIDE**

MENS

MEASUREMENT POINT	XXS / XS	S / M	L / XL	2XL / 3XL	5XL
1/2 CHEST WIDTH	54	58	62	66	70
1/2 HEM	53	57	61	65	69
BACK BODY LENGTH INCLUDING THE WAISTBAND	68	72	76	80	83

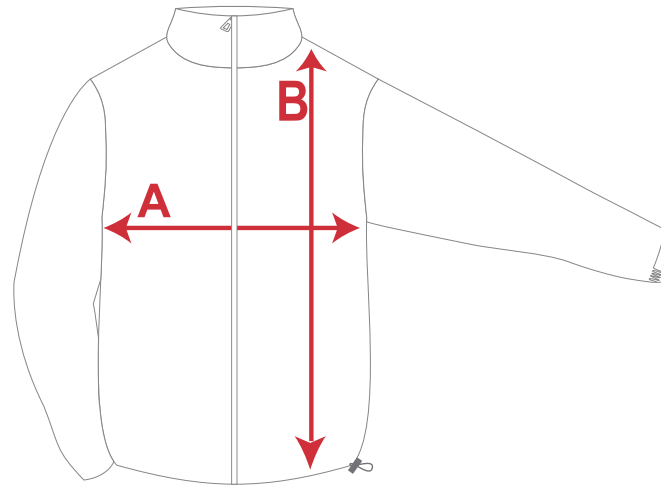

**A - CHEST WIDTH
B - BODY LENGTH**

UNISEX K2 PRO TRACKPANTS

EVEREST SPORTSWEAR SPEC

BACKRISE 12CM LONGER ON ALL SIZING

MEASUREMENT POINT	XS	S	M	L	XL	2XL	3XL
WAIST 1/2	34	35	37.5	40	42	45	47.5
LENGTH INCLUDING WAISTBAND	95	98	100	103	105	108	110
HIP 1/2	47	49	51	53	55	57	59
THIGH 1/2	30	31	32	33	34	35	37
BOTTOM LEG OPENING 1/2	14	14.5	15	15.5	16	17	17.5
FRONT RISE INCLUDING WAISTBAND	27	28	29	30	31	32	33

JUNIOR K2 PRO TRACKPANTS

EVEREST SPORTSWEAR SPEC

BACKRISE 12CM LONGER ON ALL SIZING

MEASUREMENT POINT	6	8	10	12	14
WAIST 1/2	25	27.5	30	32.5	33
LENGTH INCLUDING WAISTBAND	80	83	85	88	90
HIP 1/2	37.5	39.5	41.5	43.5	45.5
THIGH 1/2	24	25	26	27	28.5
BOTTOM LEG OPENING 1/2	10	11	12	13	14
FRONT RISE INCLUDING WAISTBAND	22	23	24	25	26

WOMENS K2 PRO TRACKPANTS

EVEREST SPORTSWEAR SPEC

MEASUREMENT POINT	W8	W10	W12	W14	W16	W18	W20	W22
WAIST 1/2	31	34	38	42	46	49	52	55
LENGTH INCLUDING WAISTBAND	94.5	95	96	97	100	102	104	106
HIP 1/2	46	49.5	53	56	59	61	63.5	65.5
THIGH 1/2	23	24	26	27	28.5	30	32	35
BOTTOM LEG OPENING 1/2	10.5	11	12.5	13	14	12	13	14
FRONT RISE INCLUDING WAISTBAND	24	25	27	28	30	32	35	38

BACKRISE 12CM LONGER ON ALL SIZING

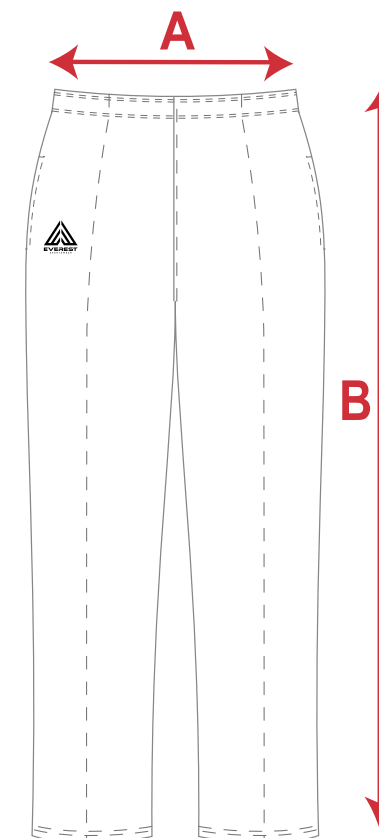

A - WAIST WIDTH
B - BODY LENGTH

MENS K2 PRO CRICKET PANTS AUSTRALIAN SPEC

MEASUREMENT POINT	10	12	XS	S	M	L	XL	2XL	3XL
WAIST	26	28	32	34	36	38	40	42	44
LENGTH	90	93	97	100	105	107	112	113	116

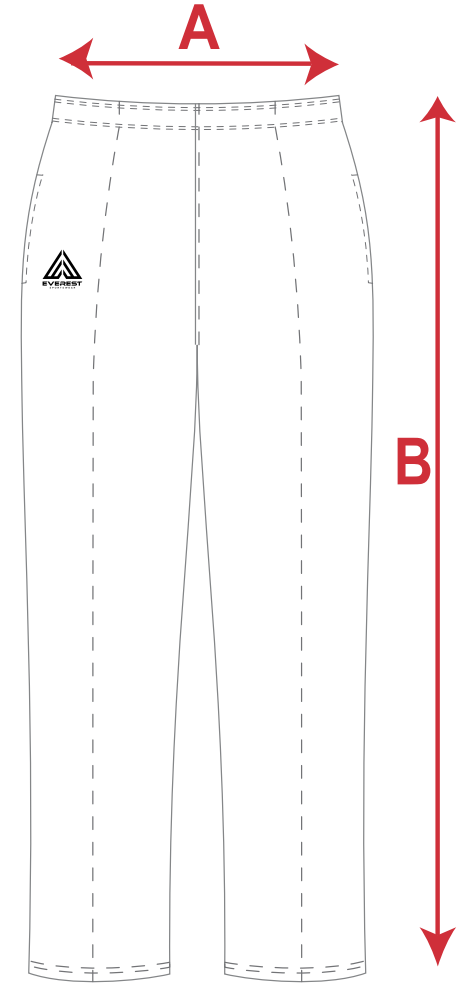

A - WAIST WIDTH
B - BODY LENGTH

K2 PRO DRESS EVEREST SPORTSWEAR SPEC

MEASUREMENT POINT	4	6	8	10	12	14	16	18	20	22
1/2 CHEST WIDTH	32	35	38	40	43	45.5	48	51	53	55
1/2 HEM	52	56	59	61	63	66	68	70	72	74
BACK BODY LENGTH	67	72	78	81	83	87	87	88	91	93

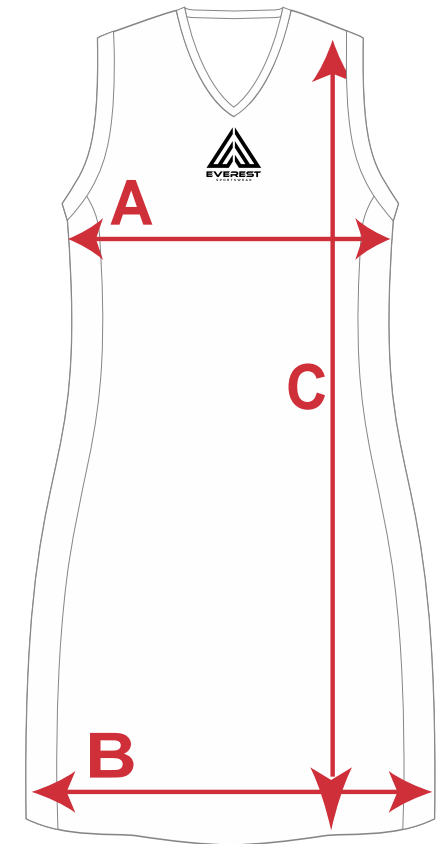

A - CHEST WIDTH
B - HEM WIDTH
C - BODY LENGTH

SKORTS

MEASUREMENT POINT	W6	W8	W10	W12	W14	W16	W18	W20	W22
WAIST - HALF (ACROSS FRONT)	30	32	34	36	38	40	42	44	46
OUTSIDE LENGTH	34.5	35	36	37.5	38.5	39	40	41	41.5

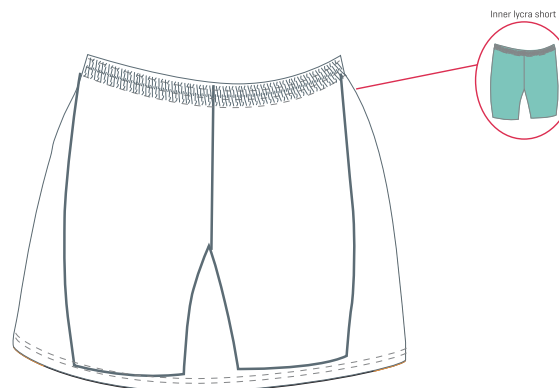

K2 PRO SKIRT

POM DESCRIPTION	MEASUREMENT POSITION	6	8	10	12	14	16	18
SKIRT								
POM HALF WAIST RELAXED	Measured straight across to top of the waistband	32	34	36	38	40	42	44
POM HALF WAIST EXTENDED	Measured straight across to top of the waistband extended	45	47	49	51	53	55	57
POM HALF HEM	Measured along the half hem edge	57	59	61	63	65	67	69
POM CENTRE BACK LENGTH	Measured from the top of the waistband to hem edge	31.5	32.5	33.5	34.5	35.5	36.5	37.5
WRAP CROSSOVER (WRAP OPTIONS ONLY)								
POM FRONT WRAP WIDTH	Measured at the waistband seam from side seam to wrap edge	32	34	36	38	40	42	44

A - CHEST WIDTH
B - HEM WIDTH
C - BODY LENGTH

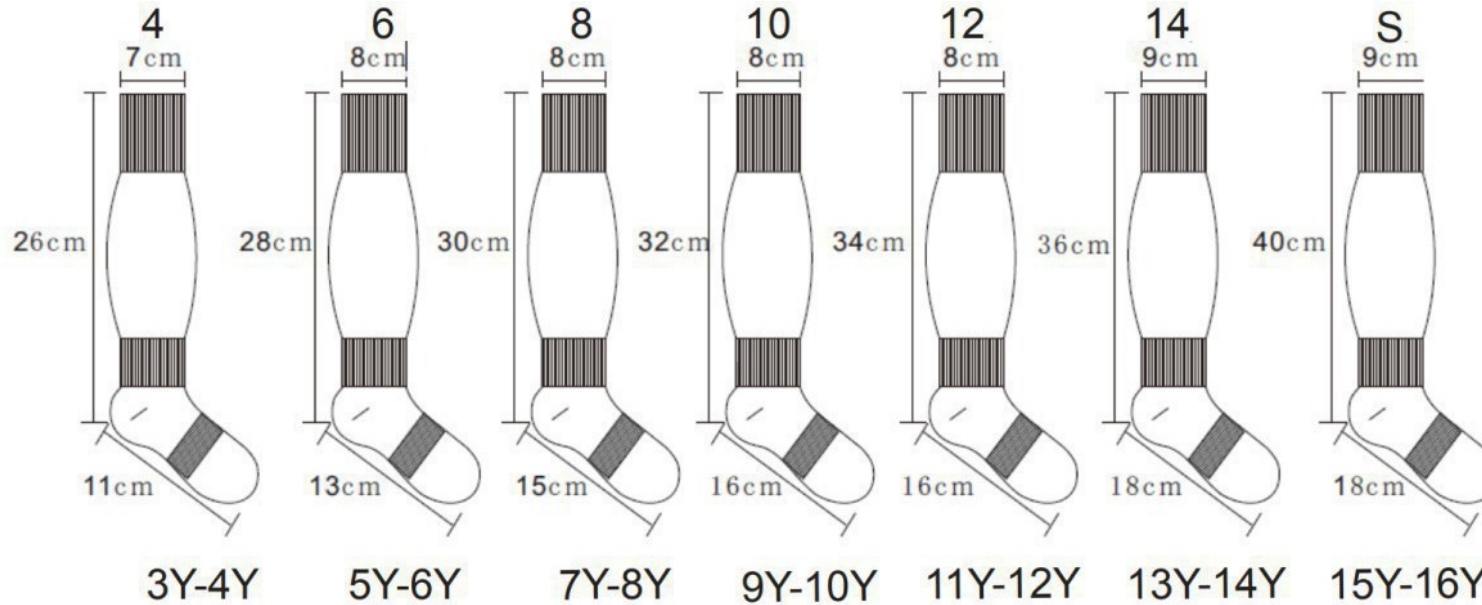
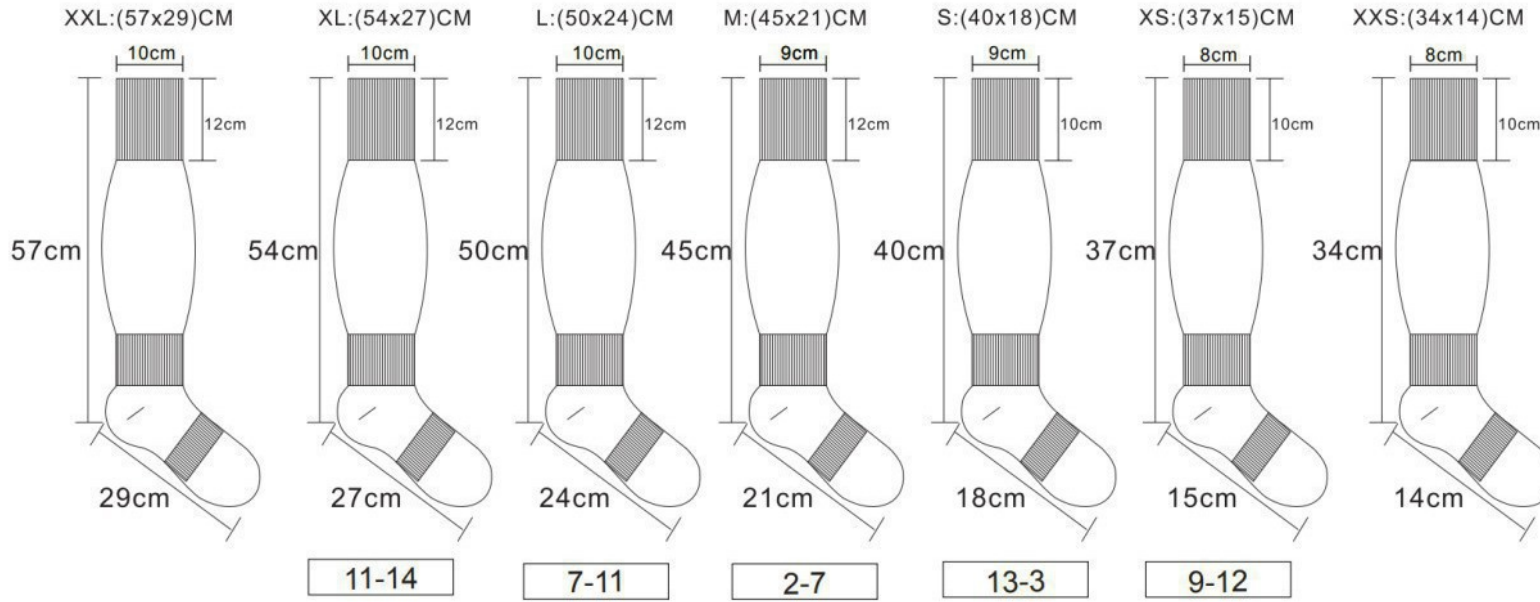

MENS SWIMMERS

MEASUREMENT POINT	XS	S	M	L	XL	2XL	3XL
A = WAIST WIDTH - RELAXED	34	37	40	43	46	49	52
B = CRUTCH WIDTH	10	10	10	10	11	11	11
C = HIP - ACROSS TOPLength	35	38	41	43	45	47	49
D = CRUTCH WIDTH HALF WIDTH - RELAXED	12	13	14	16	18	20	21
E = HIP HEIGHT LENGTH SIDES	7	7	7	7	8	8	8
F = BACKSIDE - MIDDLE RELAXED	27	28	29	30	31	32	33
G = BACKSIDE CRUTCH WIDTH - RELAXED	12	12	12	13	13	13.5	14
H = LENGTH INC WAIST BAND 2CM TO CRUTCH SEAM	26	26	26	27	27	27	27.5
I = LEG OPENING ON THE HALF	20	22	23	24.5	26	26.5	27

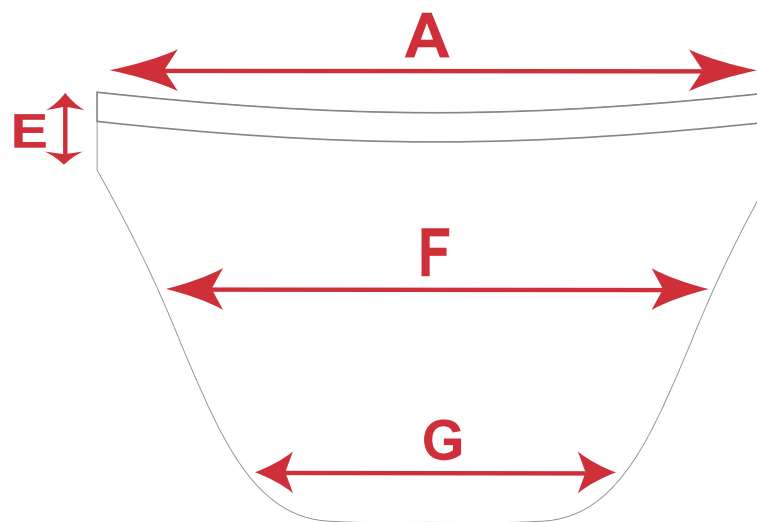
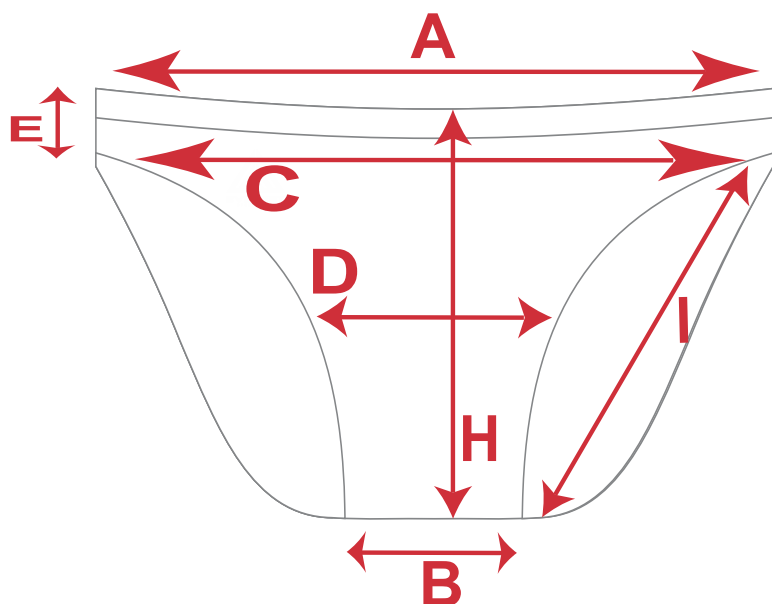

SIZES ARE LISTED IN CM